

产品检验图

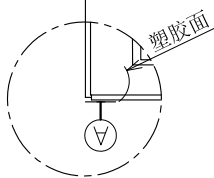

详细图C
SCALE: 2:1

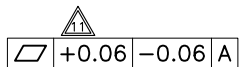
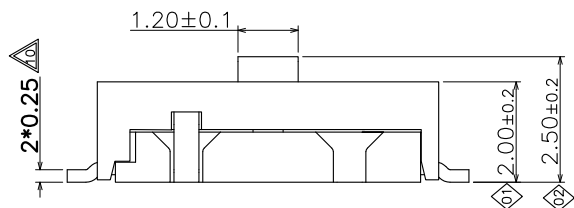
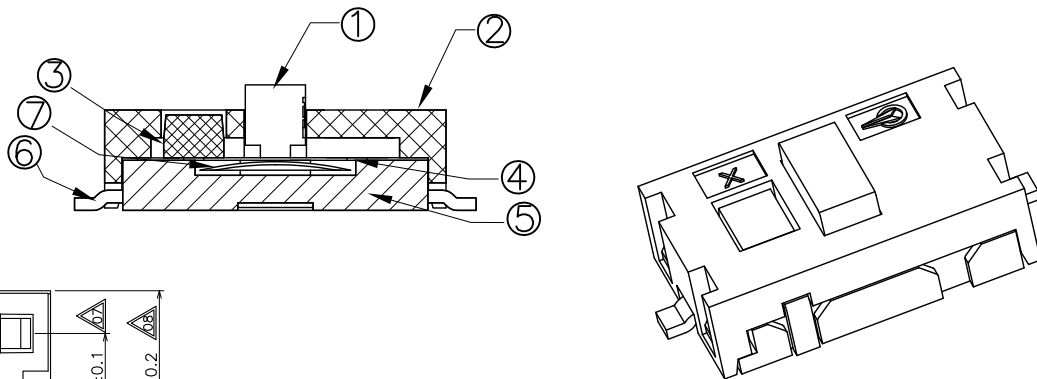
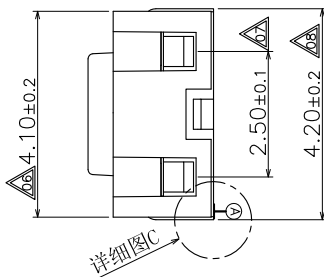
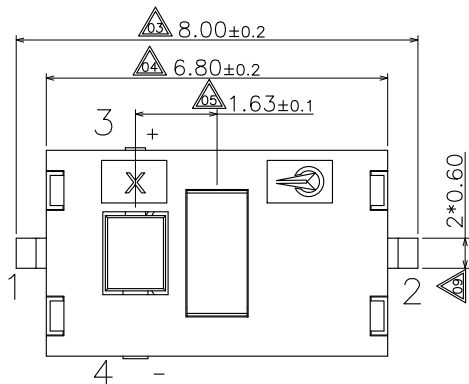
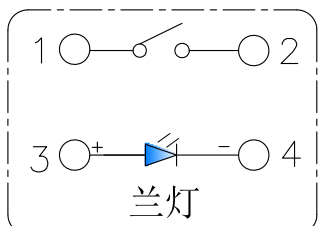

Circuit diagram

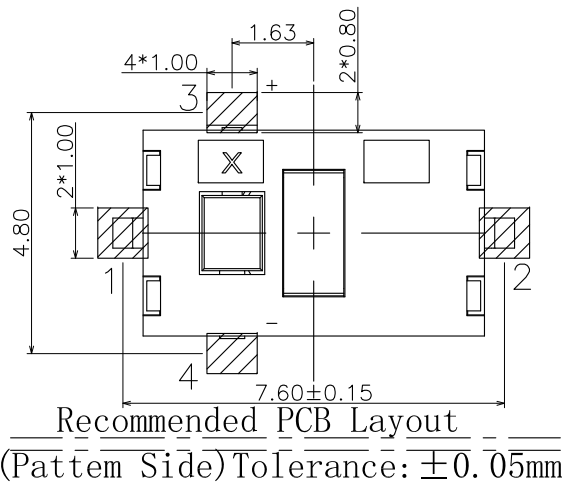

产品规格:

1. 额定值: DC12V 50mA
2. 接触阻抗: 100mΩ Max
3. 绝缘阻抗: 100MΩ Min (DC250V)
4. 耐高压: AC 250V (50-60HZ) 持续1分钟
5. 操作力: 160+80/-30gf
6. 行程: 0.20±0.15mm
7. 机械寿命: 5万次以上
8. 此产品须符合<<凯华环境有害物质管制标准>>

备注:

- ◇: 表示重点管控尺寸, 一般为功能尺寸, 首检及巡检时需量测。
- △: 表示次重点管控尺寸, 一般为装配尺寸, 首检时需量测。
- 1) 重点及次重点管控尺寸中的序号不可重复, 需依次往后增加。若其中有某个尺寸在变更或其它状况下, 尺寸消失或不要求管控时, 原序号不可再用。有其它尺寸需要增加管控时, 序号往后增加。
- 2) 版次定义: 新开发而未转量产之产品图面版次为A1, A2, A3...
- 已转量产之产品图面版次为A, B, C...

序号	零件名称	零件料号	用量	材料	镀层/颜色	备注
⑦	φ3.0弹片	BWLAXXX-03013	1	SUS301-EH	单面镀银	160gf
⑥	端子	BWLA6825-01001	1	H65Y T=0.25	镀银	
⑤	基座	BZLA6825-02001S0	1	PA9T+20%GF	黑色/镀银	
④	PI膜	YF99003	1	PI	黄色	
③	LED	BZLAXXX-08067	1	小蝴蝶平头兰灯		
②	2#盖子	BSLA6825-04002	1	PA10T+30%GF	白色	色粉: YF01131
①	导芯	BSLA6825-05001	1	PA10T+30%GF	白色	色粉: YF01131

承认	日期	东莞市凯华电子有限公司 DONGGUAN CITY KAIHUA ELECTRONICS CO.,LTD				
设计	赖由雄		2019.01.03			
审核						
核准		名称	LA6825带灯开关			
		料号	CLA682501S02			
未注尺寸公差	30<L	±0.30	角度	单位: mm	比例: 1:1	视角
	10<L≤30	±0.20				
	5<L≤10	±0.15	±2'	图号	KHA-LA6825-002	页数 1 OF 1
	L≤5	±0.10				

工程变更单号	版次	日期	说明	修改	审核	核准
ECN-1901-01	C	2019.01.03	调整尺寸公差	赖由雄		
ECN-1709-20	B	2017.09.28	修正图面	胡前程		
	A		NEW			



凱華電子
KAIHUA EEELETRONICS

Document Number:

KH-PS1701-34

产品规格书

Product Specification

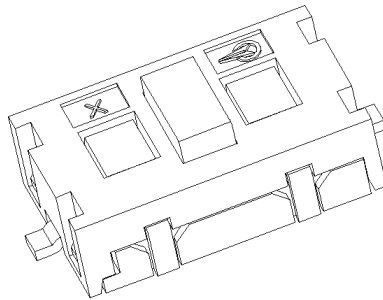

P/N: CLA682501S01			Title : Lamp Switch		
Rev.	ECN	Release and Revision Description:	Prepared By/Date:	Checked By/Date:	Approved By/Date:
A	-----	New releasing 初版发行	胡前程 2017.08.15	吕攀豪 2017.08.15	David2017.08.15



P/N:	DOC. No.:	Rev.:	Page:
CLA682501S01	KH-PS1701-34	A	2/10

Content

目录

1. Scope/范围:.....	3
2. Product Application/产品应用 :	3
3. Technology Parameters/技术参数	3
4. Ratings/额定性能要求.....	3
5. Profile Dimensions /外形尺寸	3
6. Electrical Performance/电气性能	4
7. Mechanical Performance/机械性能.....	5
8. Environmental Performance/环境性能.....	7
9. Recommended PCB Layout/推荐的 PCB 安装焊盘规格	9
10. Packaging 包装:	9
11. Precaution/注意事项	10



P/N: CLA682501S01	DOC. No.: KH-PS1701-34	Rev.: A	Page: 3/10
-----------------------------	----------------------------------	-------------------	----------------------

1. Scope/范围:

This Product Specification covers the requirement of Lamp Switch on product performance, test methods and quality assurance provisions.
本规格书内容涵盖带灯开关产品的要求，包括性能指标、测试方法及质量保证方面等。

2. Product Application/产品应用:

The Switch is applied in all types of electrical appliances. Please let us know before using any of the products in the application not described above.
该开关产品适用于各种电器，如果用于本文中未提及的领域请在使用前告知。

3. Technology Parameters/技术参数:

Ambient Humidity 工作湿度:	45~85% R.H.;
Operating Temperature Range 使用温度范围:	-10℃~+70℃;
Storage Temperature Range 保存温度范围:	-20℃~+80℃;
Normal Condition:	
Ambient temperature 环境温度:	20±5℃
Relative humidity 相对湿度:	65%±5% R.H.;
Air pressure 气压:	86~101KPa;
Contact Resistance 接触阻抗:	100 mΩ Max;
Operation Force 操作力:	160+80/-30gf;
Solder Ability 可焊性:	245±5℃,3±0.5s;
Withstand Soldering Temperature 耐焊接热:	260±5℃,3±0.5s;

4. Ratings/额定性能要求:

Rating 额定负荷:	DC12V / 50mA;
Insulation Resistance 绝缘电阻:	≥100MΩ/ DC 250V;
Withstand Voltage 耐电压:	250V AC 1 Minute;
Mechanical Life 机械寿命:	50,000 Cycles(Min).

5. Profile Dimensions /外形尺寸:

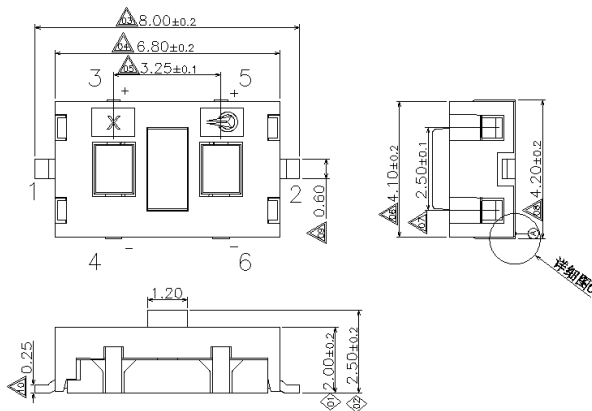

6. Electrical Performance/电气性能:



Item 项目	Description 项目描述	Test Condition 测试条件	Requirement 规格要求
6.1	Contact Resistance 接触电阻	<p>Static load: (Operation force)x2, which is applied on the center of Switch stem. 静态负载: 动作力的 2 倍, 施加在手柄中心.</p> <p>Measurement tool: Contact resistance Meter. 测量工具: 微电流接触电阻计(1KHz, 20mV,5~50mA)</p> <p>在低电流 (≤100mA) 条件下测试. Measured at low current (100mA or less).</p>	<p>100mΩ Max 100mΩ 以下</p>
6.2	Insulation Resistance 绝缘电阻	<p>Apply a Voltage of DC 250 V for 1 minute, according to the below method. (1) Between terminals. (2) Between terminal and Body.</p> <p>输入 250V DC 电压 1 分钟, 按如下接触方法测试: (1) 端子与端子之间. (2) 端子与外壳之间.</p>	<p>100MΩ Min 100 兆欧以上</p>
6.3	Dielectric withstanding voltage 耐电压	<p>Apply a Voltage of AC 250 V (50~60Hz) for 1 minute, according to the below method. (1) Between terminals. (2) Between terminal and Body.</p> <p>输入 250V AC 电压 1 分钟, 按如下接触方法测试: (1) 端子与端子之间. (2) 端子与外壳之间.</p>	<p>No evidence of breakdown 无瞬断、击穿等破坏.</p>
6.4	Bouncing 触点抖动	<p>Operation speed: 3~4 times/s 操作速度: 每秒 3~4 次</p> <p>Slightly push the center of stem by 3~4 times/s, to test the bounce at "ON" and "OFF" 以每秒 3~4 次的速度, 轻轻在手柄中心加力, 在"导通"与"瞬断"间测试.</p> <p>Oscillo scope 示波器 Switch Bouncing Test Circuit 抖动测定回路.</p>	<p>Before Life cycle: On: 5ms MAX,5 毫秒以下 Off: 5ms MAX,5 毫秒以下</p> <p>After Life cycle: On: 10ms MAX,10 毫秒以下 Off: 10ms MAX,10 毫秒以下</p>



触点抖动用图:

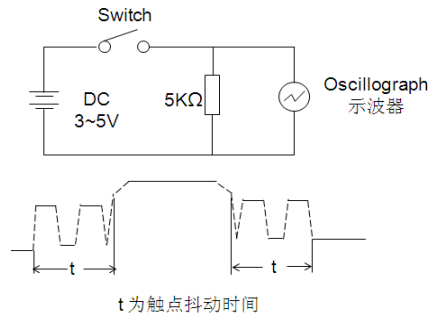

7. Mechanical Performance/机械性能:

Item 项目	Description 项目描述	Test Condition 测试条件	Requirement 规格要求
7.1	Operation force 操作力	Operate the keystroke of the switch and then increase press strength gradually, Measured maximum operation force while the travel of the switch is full. 逐渐施力操作开关按键，测量开关到达全部工作行程时所需的最大操作力度。	160 +80/-30gf
7.2	Travel 行程	Operate the keystroke of the switch vertically, the travel distance of keystroke moving from its free position to maximum moving distance shall be measurement. 垂直操作开关按键，量测开关顶端最大移动距离。	0.20±0.15mm

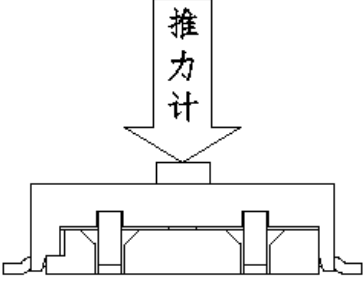
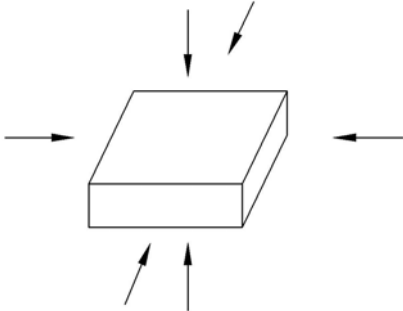

7.3	Static Strength 静止强度	<p>A static load of 1Kgf shall be applied in the direction of button operation for a period of 60 seconds. 在手柄动作方向施加 1kgf 的静负荷 60 秒, 然后测试参数.</p> 	No damage (Electrical and mechanical) 电气和机械性能正常.
7.4	Stem Pull Strength 手柄拉拔强度	<p>Break by a pull force applied opposite to the direction of stem operation. 在推柄动作方向反向垂直施加拉力, 使其破坏的程度.</p>	500gf Min
7.5	Shock 机械冲击	<p>Measured by according to the below condition: (1) Acceleration: 80g 加速度 (2) Cycles of test: 3 cycles each in 6 directions, for a total of 18 cycles. 试验次数: 每个方向 3 次, 6 个方向共 18 次.</p> 	Shall meet No.6, 7.1, 7.2. 满足 6, 7.1, 7.2 要求.



7.6	Life Test 寿命测试	<p>(1) Weight:250gf 砝码: 250gf</p> <p>(2) Operation speed: 60 cycles/min 操作速度: 60 次/分钟</p> <p>(3) Push force: Maximum value of operation force. 按压力: 操作力规格值的上限.</p> <p>(4) Cycles: 50,000 times Min 操作次数: 50,000 次以上(最小)</p>	<p>Contact resistance: 10000 mΩ Max 接触电阻: 10000 毫欧以下</p> <p>Bouncing: 10ms Max 触点抖动: 10 毫秒以下</p> <p>Operation force: Variation rate within ±30% 操作力的变化范围在初始值的±30%以内.</p>
-----	-------------------	---	--

8. Environmental Performance/环境性能:

Item 项目	Description 项目描述	Test Condition 测试条件	Requirement 规格要求															
8.1	Cold test 耐寒性	<p>(1) Temperature : - 20±2℃ 温度: - 20±2℃</p> <p>(2) Duration of test: 96h 持续时间: 96 小时</p> <p>(3) Take off a drop water 去掉水珠</p> <p>(4) Standard conditions after test : 1h 试验后的放置条件: 1 小时</p>	<p>Contact resistance: 200mΩ Max Shall meet : No. 6.2 to 6.4 No. 7.1 to 7.2 接触电阻 200mΩ 以下 满足: No. 6.2 to 6.4 No. 7.1 to 7.2</p>															
8.2	Heat test 耐热性	<p>(1) Temperature : 80±2℃ 温度: 80±2℃</p> <p>(2) Duration of test: 96h 持续时间: 96 小时</p> <p>(3) Take off a drop water 去掉水珠</p> <p>(4) Standard conditions after test : 1h 试验后的放置条件: 1 小时</p>	<p>Contact resistance: 200mΩ Max Shall meet : No. 6.2 to 6.4 No. 7.1 to 7.2 接触电阻 200mΩ 以下 满足: No. 6.2 to 6.4 No. 7.1 to 7.2</p>															
8.3	Temperature cycle 温度循环	<p>(1) Test cycles: 5 cycles 试验周期: 5 个周期</p> <p>(2) Standard condition after test:1h 试验后的放置条件: 1 小时</p> <table border="1" style="width: 100%; border-collapse: collapse;"> <thead> <tr> <th></th> <th style="text-align: center;">Temperature 温度</th> <th style="text-align: center;">Duration of test 持续时间</th> </tr> </thead> <tbody> <tr> <td style="text-align: center;">1 cycle 一次循环</td> <td style="text-align: center;">20±5℃</td> <td style="text-align: center;">1h</td> </tr> <tr> <td></td> <td style="text-align: center;">-20±2℃</td> <td style="text-align: center;">1h</td> </tr> <tr> <td></td> <td style="text-align: center;">20±5℃</td> <td style="text-align: center;">1h</td> </tr> <tr> <td></td> <td style="text-align: center;">80±5℃</td> <td style="text-align: center;">1h</td> </tr> </tbody> </table>		Temperature 温度	Duration of test 持续时间	1 cycle 一次循环	20±5℃	1h		-20±2℃	1h		20±5℃	1h		80±5℃	1h	<p>Contact resistance: 200mΩ Max Shall meet : No. 6.2 to 6.4 No. 7.1 to 7.2 接触电阻 200mΩ 以下 满足: No. 6.2 to 6.4 No. 7.1 to 7.2</p>
	Temperature 温度	Duration of test 持续时间																
1 cycle 一次循环	20±5℃	1h																
	-20±2℃	1h																
	20±5℃	1h																
	80±5℃	1h																



8.4	Soldering heat test 耐焊接热	<p>Soldering area: T/2 of PWB thickness. (PWB: T=1.6mm) 焊接面积: 印刷基板的 1/2 厚度处</p> <p>Soldering temperature: 260±5°C 焊接温度: 260±5°C</p> <p>Soldering time: 3±0.5s 焊接时间: 3±0.5 秒</p>	Appearance: No abnormality. 外观无异常
8.5	Solderability 可焊性	<p>1. Hand soldering 手工焊接: Please practice according to below condition: (1) Soldering Temperature : 350±5°C 焊接温度: 350±5°C (2) Continual soldering time: 3±0.5s 连续焊接时间: 3±0.5 秒 (3) Capacity of soldering iron: ≤20w 电烙铁功率: 20 瓦以下</p> <p>2. Automatic Reflow soldering 自动回流焊接: For the product of SMT, according to below condition:</p> <p style="text-align: center;">SMT 回流焊温度曲线图</p>	At least 90% of surface area of immersed portion shall be covered by solder. 侵焊面积大于 90%以上
8.6	Humidity test 耐湿性	<p>(1) Temperature : 60±2°C 温度: 60±2°C</p> <p>(2) relative humidity: 90~95% R.H. 相对湿度: 90~95% R.H.</p> <p>(3) Duration of test: 96h 持续时间: 96 小时</p> <p>(4) Take off a drop water 去掉水珠</p> <p>(5) Standard conditions after test: 1h 试验后的放置条件: 1 小时</p>	Contact resistance: 200m Ω Max Shall meet : No. 6.2 to 6.4 No. 7.1 to 7.2 接触电阻 200m Ω 以下 满足: No. 6.2 to 6.4 No. 7.1 to 7.2



P/N: CLA682501S01	DOC. No.: KH-PS1701-34	Rev.: A	Page: 9/10
-----------------------------	----------------------------------	-------------------	----------------------

8.7	Salt Spray 盐雾测试	<p>Apply the following environment to test: 根据下列条件进行测试:</p> <p>(1) Temperature : 35±5°C 温度: 35±, 5°C;</p> <p>(2) Salt water density: 5±1% 盐水浓度: 5±1%;</p> <p>(3) Duration: 24 hours 持续时间: 24 小时;</p> <p>(4) After test, the salt deposit shall be removed by running water. 实验后将盐沉积物用水冲掉</p>	<p>Appearance: No corrosion spot, no crack, no base plate naked. 外观: 无腐蚀点, 无裂纹, 无裸露基材.</p> <p>Contact Resistance: 200 mΩ Max 接触电阻: 200 毫欧以下</p>
8.8	Withstand K ₂ S 硫化测试	<p>Apply the following environment to test: 根据下列条件进行测试</p> <p>(1) Temperature: 35±5°C 温度: 35±5°C</p> <p>(2) K₂S Density: 2% 硫化钾浓度: 2%</p> <p>(3) Duration: 2 minute. 持续时间: 2 分钟</p>	<p>Appearance: No corrosion spot, no crack, no base plate naked. 外观: 无腐蚀点, 无裂纹, 无裸露基材.</p> <p>Contact Resistance: 200 mΩ Max 接触电阻: 200 毫欧以下</p>

9. Recommended PCB Layout 推荐的 PCB 安装焊盘规格

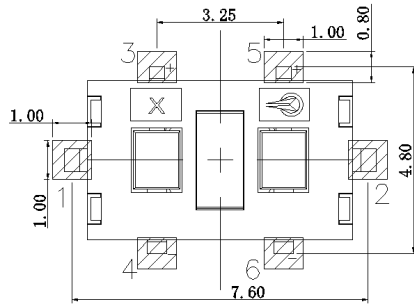

10. Packaging 包装

Packaging type: Tape & Reel, 2000Pcs/ Reel, 40000Pcs/ Carton.

包装方式: 卷盘包装, 2000Pcs/盘. 40000Pcs/箱

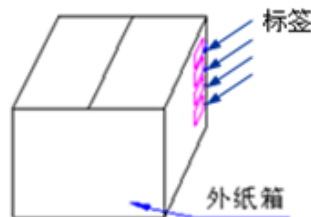
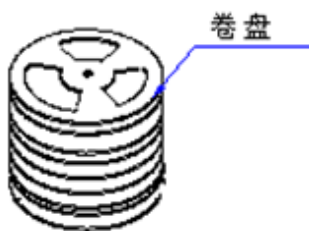



11. Precaution 注意事项:

11.1 Immersion Soldering condition 浸焊条件

ITEM 项目	CONDITION 条件
Preheat temperature 预热温度	110°C Max (Ambient temperature of soldering surface of P.W.B) 110°C 以下(印刷基板焊锡面周围的温度)
Preheat time 预热时间	60s, Max 60 秒以内
Area of flux 助焊剂面积	1/2 Max of PWB Thickness 印刷基板厚度的 1/2 以内
Temperature of solder 焊锡温度	260±5°C 260±5°C
Time of immersion 浸焊时间	Within 5s 5 秒以内
Number of soldering 焊接次数	2time Max (But should down heat of the first soldering) 2 次以内
Printed wiring board 印刷基板	Single side copper-clad laminates 单面铜箔

- (1) After switches were soldered, please be careful not to clean switches with solvent
开关浸焊后,注意不要用溶剂清洗.
- (2) Under the condition of using soldering iron, soldering temperature shall be 350°C max within 3 sec.
在使用烙铁的情况下,焊锡温度应在350°C以下,焊接时间3秒以内.

11.2 Notes 注意点:

- (1) Please be cautious not to give excessive static load or shock to switches.
注意不要施加超负荷的压力或晃动开关.
- (2) Please be careful not to stack up P. W. B. after switches were soldered.
开关焊接以后,印刷基板注意不要叠放.
- (3) Preservation under high temperature and high humidity or corrosive gas should be avoided Especially. When you need to preserve for a long period, do not open the carton.
保管时尤其应注意避开高湿高温和有腐蚀性气体的环境. 如需长时间保存,请不要打开包装箱.
- (4) Products meet the ROHS & REACH environmental management substances control standards
产品满足 **ROHS & REACH** 环境管理物质管制标准